

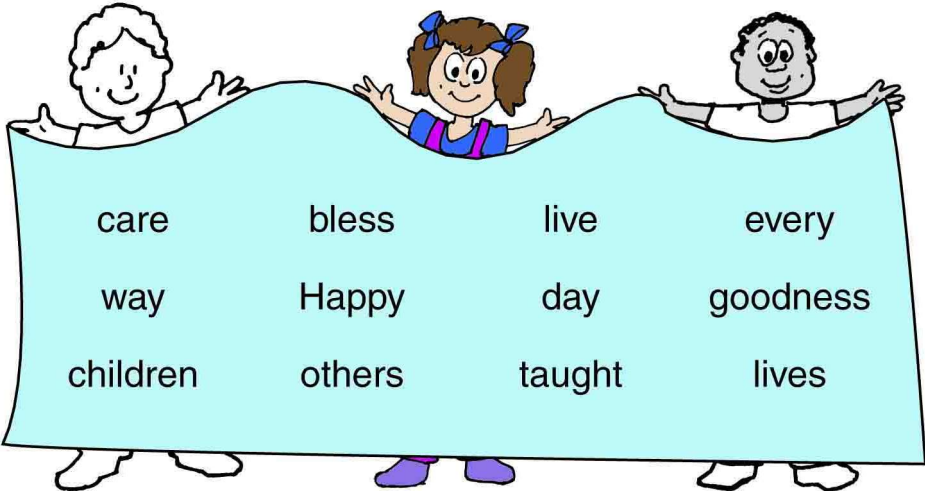

The book of Psalms is a collection of 150 songs and poems. There are Psalms of praise, worship, history and prayer. They were probably written between 1400 and 500 B.C.

Let's write a Psalm today!
Match the shapes with the words below.

are the who
 about and in the
 that God has . God will their
 with . God will be with
 them .



The Two Ways

“_____ is the one who does not walk in the counsel of the wicked or stand in the way of sinners or sit in the seat of mockers. But his delight is in the law of the Lord ...” –Psalm 1:1-2

Find the missing word. Arrange the 5-letter words below in alphabetical order from top to bottom. The second letter of each word will form the missing word.

DEBUT

ISSUE

ODORS

ABIDE

ESSAY

BLOOM

JEWEL

Connect the dots. Write the words in order, then read some of the words from the Psalm.

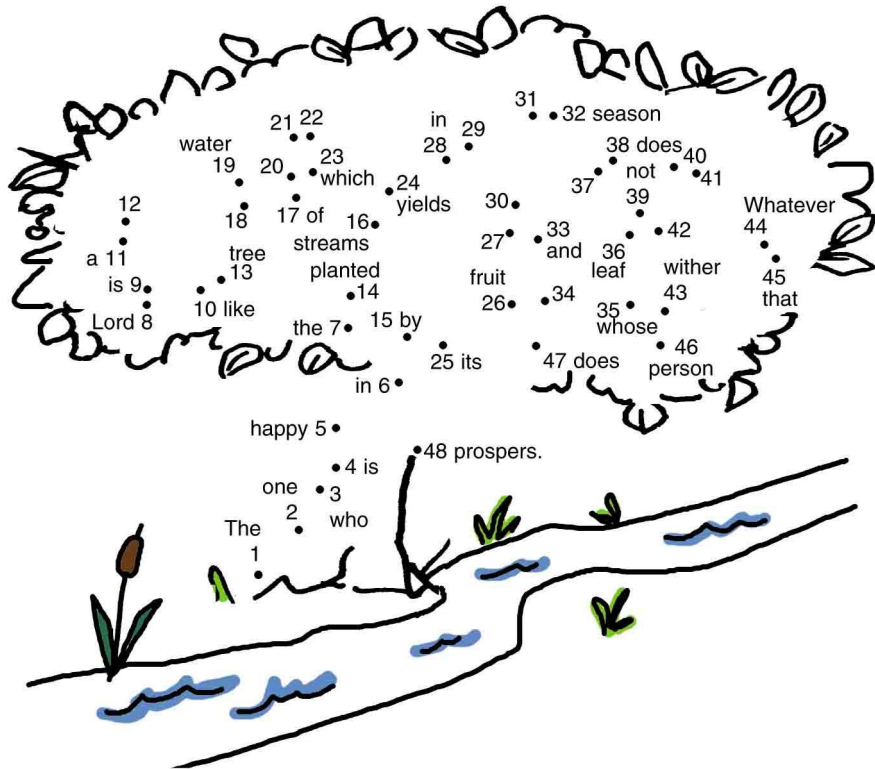

“ _____

 _____,

 _____.”

The Psalm also says...

Beginning with the second letter, cross out every other letter. The remaining letters are words from the Psalm.

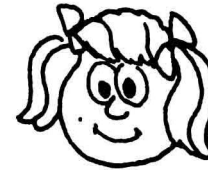

START

T A H B E C L D O E R F D G W H
 T A H B E C R D I E G G H
 T Y U O V F W T X H Y
 L K L K P L E
 M R
 E Z W A
 W G I J
 N I O S P H
 I B C K D E E D F
 Q E R W S A
 P H
 K S L B M U N T O T P H
 A I T J C K H L E M S
 N O O V P E Q R R T S H T E U W

“ _____
 _____,
 _____.”

OUR PURPOSE



*Loving God
Welcoming All
Serving Neighbors
Together through
Jesus Christ*

DAILY SCRIPTURE READINGS

Sun., May 30 - **JOHN 8:12-19** *The Light*
Mon., May 31 - **PHILIPPIANS 1:3-8** *Connected by Prayer*
Tue., June 1 - **PSALM 119:1-16** *A Broken World*
Wed., June 2 - **HEBREWS 13:1-6** *Compassionate Listening*
Thu., June 3 - **PHILIPPIANS 4:4-7** *Beyond All Understanding*
Fri., June 4 - **PSALM 19:1-9** *Reminders of God*
Sat., June 5 - **1 CORINTHIANS 2:9-13** *Nurturing Love*

Visit www.upperroom.com for more information.

OFFICE INFORMATION

COORDINATOR HOURS

Monday-Friday, 9am-Noon

PASTORAL APPOINTMENTS

Please contact the office at 301-349-2010, office@pmumc.org, or visit www.pmumc.org

PHONE MESSAGES

Messages sent to designated email accounts.

EMERGENCIES

For immediate pastoral care, please email Pastor Tim at PastorTim@PMUMC.org

CHURCH GIVING

AVERAGE WEEKLY GIVING *(last 8 weeks)*

Not available at time of printing

WEEKLY GOAL - \$5,770

WAYS TO GIVE:

- **MAIL** to Memorial's PO Box 358
- **DROP** in Memorial's secured mailbox next to entrance
- **ELECTRONICALLY** via PMUMC.org

CHURCH PERSONNEL & CONTRIBUTORS TO WORSHIP

PASTOR - Rev. Timothy A. Dowell

CHURCH COORDINATOR-Shirley Prasada-Rao

DIRECTOR OF MUSIC - Janet Hartz

ORGANIST - Linda Custer

BELL CHOIR DIRECTOR - Becky Smalley

HEAD USHER - Dr. Robert Spiker

HEAD ACOLYTES - Charlotte Selby,
Rachel Smalley

ALTAR GUILD/COMMUNION STEWARD -
Janet Spiker

WORSHIP CMTE CHAIR - Priscilla Lyon

CUSTODIAN - Pecoe Fleming

WORSHIP ASST - Sandy Parnell-Dowell

LITURGIST - Pam Flick

ACOLYTE - Sam Baggett

ORGAN/PIANO - Linda Custer, Janet Hartz

AUDIO/VIDEO - Tim Melton, Kevin Schramm

VISUAL ARTS - Dianna McGrew, Janet Spiker

VOCALISTS - Sandi Baggett, Laura Blauch,
Link Hoewing, Wendy Huff, Tim Melton



Memorial United Methodist Church

17821 Elgin Rd. / PO Box 358, Poolesville MD 20837

301-349-2010 | office@pmumc.org

www.PMUMC.org

Sunday Worship Service
May 30, 2021 at 10:30 am



Trinity Sunday



Thank you for coming together in worship this morning. As we gather, take time to relax and prepare your heart to listen for God through today's time of prayer, song, and scripture study. As you participate with heart and/or voice, the words will be displayed on your screen for your convenience.

UMH=United Methodist Hymnal.; TFWS=The Faith We Sing.

Worship Service - May 30, 2021

Trinity Sunday

SCRIPTURES: Psalm 1 and 2 Timothy 3:14-17

CALL TO WORSHIP

LEADER: How beautiful is the word of the Lord!
 PEOPLE: **How wise are God's commandments!**
 LEADER: Through the Lord's precepts, we gain understanding.
 PEOPLE: **Through God's wisdom, we find truth.**
 LEADER: The Lord is our God; we are God's people.
 PEOPLE: **God's word lives within us,**
 LEADER: for it is written on our hearts.
 PEOPLE: **Living Word, Great Teacher, lead us and guide us! Amen!**

OPENING PRAYER

Lord, your words are sweet to the taste, sweeter than honey; let them be our daily meditation and our study. Give us ears to hear, for we marvel at your instruction. Train us in righteousness, grant us patience and persistence, and equip us for every good work. Inspire our faith, and give us voices to proclaim your message. Guide our feet, keep us from every false way, for you alone speak the words of life. Amen.

MUSIC

PRE-SERVICE *Hymn Medley* by various composers
 PRELUDE *Holy, Holy, Holy* by Joel Raney
 (Piano Duet)
 BELL ANTHEM *Battle Hymn of the Republic* by Cynthia Dobrinski
 HYMNS *This Is My Song* UMH 437
The Church's One Foundation UMH 545
 POSTLUDE *Finlandia* by Sibelius/Hughes
(Song of Peace)

UPCOMING HAPPENINGS

SUN - MAY 30 <i>Trinity Sunday</i> <i>(Memorial Day Weekend)</i>	9:15 - 10:15 am 9:30 - 10 am 10:30 - 11:30 am	Adult Sunday School - Zoom Child and Youth Sunday School - Zoom Worship Service - <i>In-Person & YouTube</i>
MON - MAY 31	All Day	Office Closed - Happy Memorial Day!
TUE - JUNE 1	7 - 8 pm 8:30 - 9:30 pm	Men's Group - Zoom <i>Task Force Committee Meeting - Zoom</i>
WED - JUNE 2	7 - 8 pm 7:30 - 9 pm	Chancel Choir Rehearsal - <i>Sanctuary</i> Trustees Meeting - <i>Fellowship Hall</i>
THU - JUNE 3	7 - 8 pm	Review/Preview with Pastor Tim - <i>Zoom</i>
SAT - JUNE 5	1 - 4 pm	The Friendly Thrift Shop Ministry
SUN - JUNE 6 <i>2nd Sunday</i> <i>after Pentecost</i>	9 - 10:15 am 9:15 - 10:15 am 10:30 - 11:30 am	Chancel Choir Rehearsal - <i>Sanctuary</i> Adult Sunday School - Zoom Worship Service - <i>In-Person & YouTube</i>
TUE - JUNE 8	7 - 8 pm	Church Council Meeting - <i>Zoom</i>
THU - JUNE 10	7 - 8 pm	Review/Preview with Pastor Tim - <i>Zoom</i>
SAT - JUNE 12	1 - 4 pm	The Friendly Thrift Shop Ministry
SUN - JUNE 13 <i>3rd Sunday</i> <i>after Pentecost</i>	9 - 10:15 am 9:15 - 10:15 am 9:30 - 9:45 am 10:30 - 11:30 am	Chancel Choir Rehearsal - <i>Sanctuary</i> Adult Sunday School - Zoom <i>Sunday School "Say, 'Hi!' Day" - Zoom</i> Worship Service - <i>In-Person & YouTube</i>



UPCOMING LITURGIST SCHEDULE

DATE	JUNE 6	JUNE 13	JUNE 20
LITURGIST	Beth Parker	Sandi Baggett	Gary Hartz

ANNOUNCEMENTS



Share a beautiful June sunset with someone you haven't talked to in at least 2 months



Church Office will be closed Wed., May 26-Mon., May 31

If there is an emergency, please call the office and leave a message, someone will return your call as soon as we can. Thank you for your understanding!

Most of Memorial's Small Groups will remain online.

If you are part of a group of 5 or less you may opt to hold your meeting in the church building while maintaining all proper social distancing protocol. To connect with a group email...

- **Worship Service** - visit www.PMUMC.org for instructions
- **Adult Sunday School** - contact Fred Lyon at cfredlyon@gmail.com
- **Youth Sunday School/VBS** - contact Betty King at bking21710@gmail.com
- **Church Council Meeting** - contact Scott McGrew at scott.mcgrew@aol.com
- **Youth Group** - contact Pastor Tim at pastortim@pmumc.org or Betty King at bking21710@gmail.com
- **Trustees Meeting** - contact Gary Hartz at gjalaska@verizon.net
- **Review/Preview with Pastor Tim** - contact Pastor Tim at pastortim@pmumc.org
- **Men's Group** - contact Ray Hoewing at RLHoewing@gmail.com

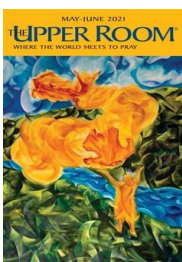

The May-June edition of THE UPPER ROOM is here! Copies are available outside on the bench or inside under the church office window. If you would like a copy mailed to you call the office.

Did you or do you have a family member that has or will graduate this year?

Please let us know so they can be celebrated!!

Office@PMUMC.org or 301-349-2010



Thank You
FOR YOUR HELP

Thank you to all those that have shared/share the love and God and the word of God by being a greeter/"welcomer" and a liturgist!

If you are Looking for a Ministry to Join—please consider being a greeter/"welcomer" or liturgist! Just give Shirley a call (301-349-2010) in the church office or send an email (office@pmumc.org) to be added to the schedule. You are needed!!



ANNOUNCEMENTS

There are so many people that provide tireless energy, enthusiasm, determination, and steadfastness to Poolesville Memorial United Methodist Church on a regular basis!

This week we want to thank Betty King and her Sunday School team including Carolyn Cline, Pam Flick, Judy Holt, and Pastor Tim for keeping/making our kids know they are loved!

THANK YOU

NOTE: Today will be the last day of regular Sunday School for this school year. However, in order to stay in touch over the summer, Sunday School will meet on Zoom for "Say, 'Hi!' Day" on the second Sunday of each month at 9:30am.

ANNOUNCEMENTS

Memorial Service for the Town of Poolesville Sunday, May 30th, 1 pm

Poolesville Presbyterian Church

17800 Elgin Road, Poolesville MD 20837

By the gazebo and the Poolesville Community Garden

Music with Gina Beck and Rick Normoyle

All are Welcome! Join Pastor David Williams and members of the community as we **honor our fallen military and recognize the sadness, grief, and loss experience during the COVID-19 pandemic.**

Together we can begin healing and usher in hope for better times ahead.

We have endured many losses as a community, including graduations, weddings, funerals, and many other missed events. We have experienced lockdown and isolation, school and business closures, and job loss.

"In this life, which we hold in common, the gift of recognizing that gracious unity is one of the greatest blessings of the Spirit... It is the essential bond of any healthy community. Things that we share together are perhaps more important to us than the things we hold separately."
Pastor David Williams

Tell your friends and neighbors. Bring your lawn chairs.



Send prayer requests to
prayers@pmumc.org.
We are here to pray for you!

The West River Center has begun its Living Shoreline project, and you can watch the progress from the comfort of your own home. A webcam captures live images 24/7 so you can see what it looks like (https://portal.hdontap.com/s/embed/?stream=westriver-center_ptz-CUST&ratio=16:9).



To learn more about the project visit <https://www.bwccmc.org/news-and-views/its-a-shore-thing-at-west-river/>.



Ready for FUN??

VBS will be here before we know it!
July 19th - July 23rd, 6 - 7:30 pm

Not only is it fun for the kids—it's a blast for the adults too! To help out with the kids or to lead an adult VBS group, send Betty an email to BKing21710@gmail.com.

ANNOUNCEMENTS

Friendly Thrift Shop

Volunteers needed every Saturday! If you can volunteer any time between 10am and 4 pm on a Saturday, even just 2 hours once a month, please contact Barbara Polak at rapbap00@yahoo.com to get on the schedule. This is a wonderful way to serve our community and show God's love through us!

Also, if you have any donations to drop off or want to shop, the new store hours are:

**Wed & Fri, 2-8pm
Thu & Sat, 10am-4pm.**

**Gather for Worship
Sundays at 10:30am**

**If you miss it—
view it any time on YouTube**

Memorial Garden & Columbarium



For complete information on

- **inurnment of cremains and/or**
- **immortalizing a past loved one's name on our Memorial Wall,**

please visit www.PMUMC.org then click on "Columbarium/Memorial Garden." You can also pick up a packet or request one be mailed.

An anonymous donor will **match donations towards our Memorial Garden & Columbarium Project received before September 1, 2021 of a least \$1,000 up to a total of \$20,000.** Please mark your donation, "Columbarium /Memorial Garden."

Summer Camp registration is open !

Do you prefer the mountains or the water? **Manidokan** is in the mountains near Harper's Ferry, WV; **West River** is near Annapolis on a tributary of the Chesapeake Bay.



Visit www.bwccampsandretreats.com

From Baltimore-Washington Conference



**Farewell
Celebration**

**DS Park's
Farewell
Celebration**

To mark this new season of ministry, the District

Committee on Superintendency is planning a Sending Forth event on June 5, 2021, at 10 AM. Registration is required, click here to RSVP: <https://bwccmc.zoom.us/meeting/register/tJAoduusrj8vGNfcsDgUXgOZCGK5hHW9Rcu6>

In preparation for the celebration, *individuals and congregations are invited to prepare a short video* using the app VIDHUG. Please submit your video by **May 31:** https://app.vidhug.com/test-1/rkV_uZCDu/record

To honor DS Park, we are collecting monetary gifts through the Conference office. Churches and individuals, please make your check payable to the Conference Treasurer and mail it to the BWC Mission Center. Remember to write ***Gift for DS Park*** in the memo section. **NOTE: BWC cannot accept electronic monetary gifts for DS Park, please mail checks instead. Thank you.**

The Lord watches over the righteous.

Find the hidden objects in the picture.



Children's Worship Bulletin™



Ages 3+

May 30, 2021 • Psalm 1:1-6

The Two Ways

Blessed is the person who does not walk in the way of the wicked.

Find the path to the restful place.



Enter your **SECRET CODE** to unlock games @ games.childrensbulletins.com

SECRET CODE
NBRTM0

Righteous people delight in the Lord.

Connect the dots.

A B C D E F G H I J K 1 2 3 4 5 6 7 8 9 10 11



A righteous person is like a tree with good fruit.

Match the seasons.

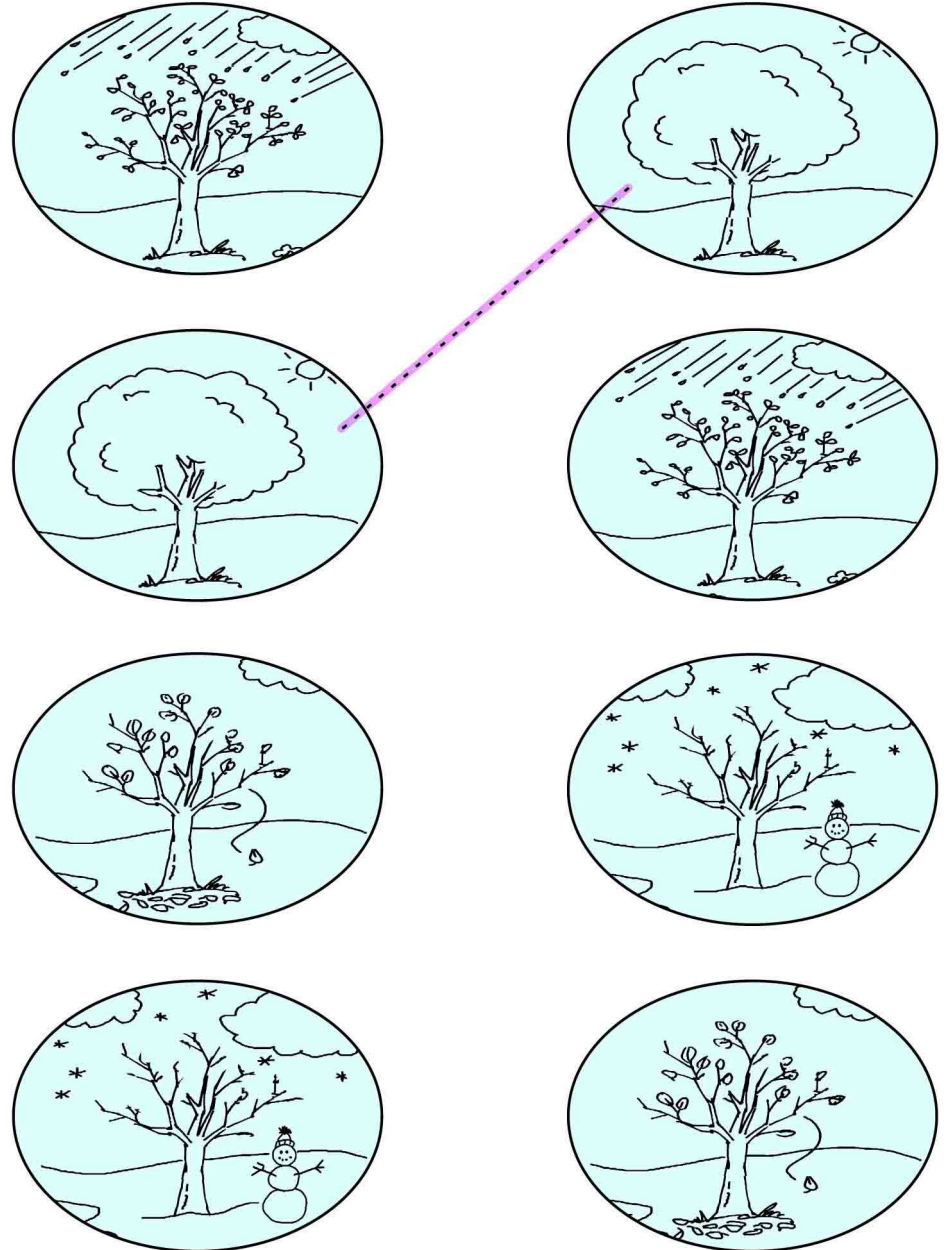

The Bible teaches us to be ready to do good deeds.

Draw a picture of yourself doing a good work.

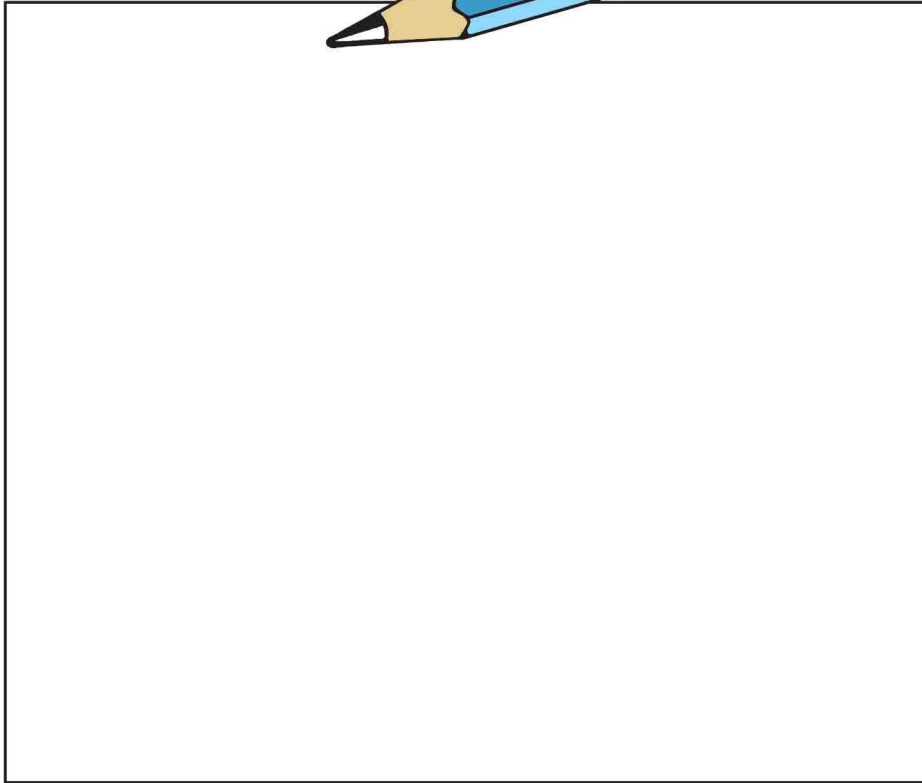
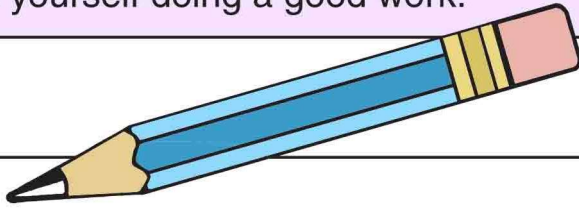

Children's Worship Bulletin™



Ages 3+

May 30, 2021 • 2 Timothy 3:14-17

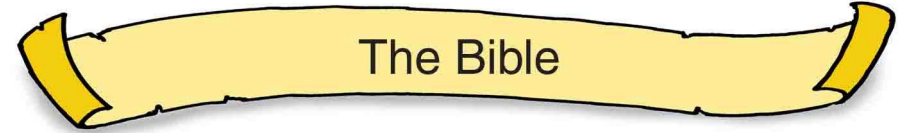

Learn from the Bible.

Match the pictures.

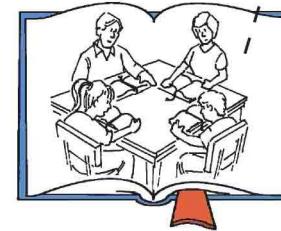

Enter your **SECRET CODE** to unlock games @ games.childrensbulletins.com

SECRET CODE
MVS206

The Bible tells us
what God wants us to know.

Use the code to fill in the missing letters.

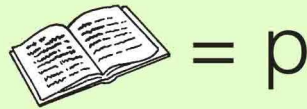
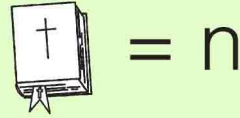

I _ s _ ire _



_ y

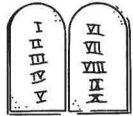

Go _ .



The Bible helps us know what is right.

Follow the maze.

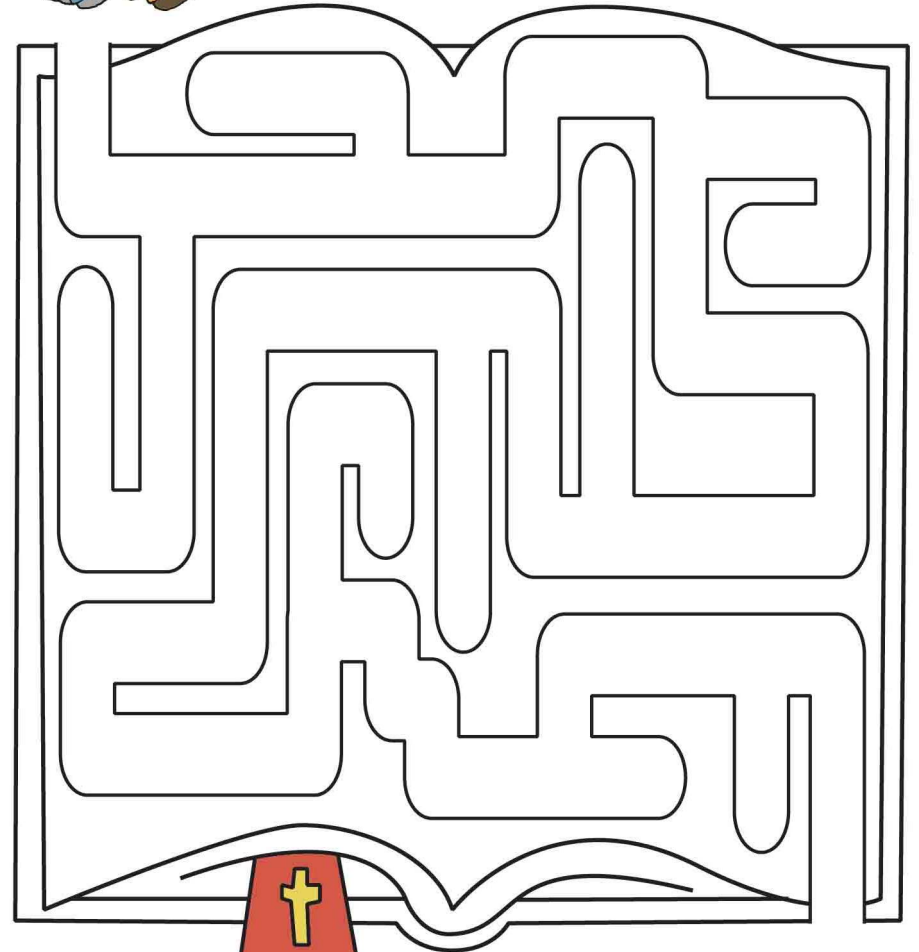

KNOW WHAT
IS RIGHT

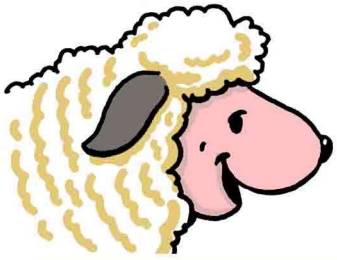

What else is the Bible intended for?

Change each letter to the one that comes next in the alphabet (Z goes to A).



“ R N S G Z S Z K K
,
F N C R O D N O K D
L Z X A D
S G N Q N T F G K X
D P T H O O D C E N Q
D U D Q X F N N C
V N Q J.”

Children's Worship Bulletin™

Ages 7+

May 30, 2021 • 2 Timothy 3:14-17

The Bible

The Bible book called 2 Timothy is a letter full of instructions for Timothy.

Solve the Sudoku puzzle, by making sure each row, column and box contains the numbers 1-9. Then unscramble the letters that go with each number to find what Timothy was told to do.

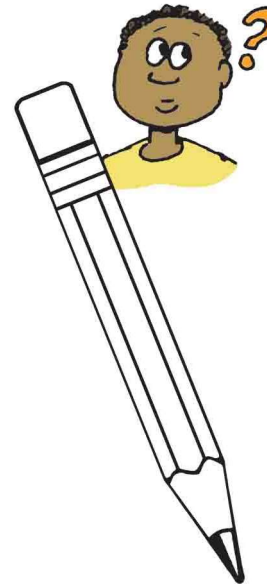

1	LEA	F	6	E	3	5	7	UE
Y	3	4	A	5	2	6	9	V
6	8	5	7	9	TIN	1	2	3
2	4	6	I	7	1	8	O	RN
HA	1	Y	O	4	9	U	6	5
5	O	9	8	3	A	2	4	1
3	5	7	4	2	8	9	1	WH
9	2	S	3	6	N	4	8	7
CON	T	8	ED	1	7	U	5	R

“As 1 2 3 , 4 5
6 7 8 9.”

Enter your **SECRET CODE** to unlock games @ games.childrensbulletins.com **SECRET CODE**
Y65849

What does this letter say about the Bible?

Find the correct path through the maze and write down the letters in the correct order to finish the quote.

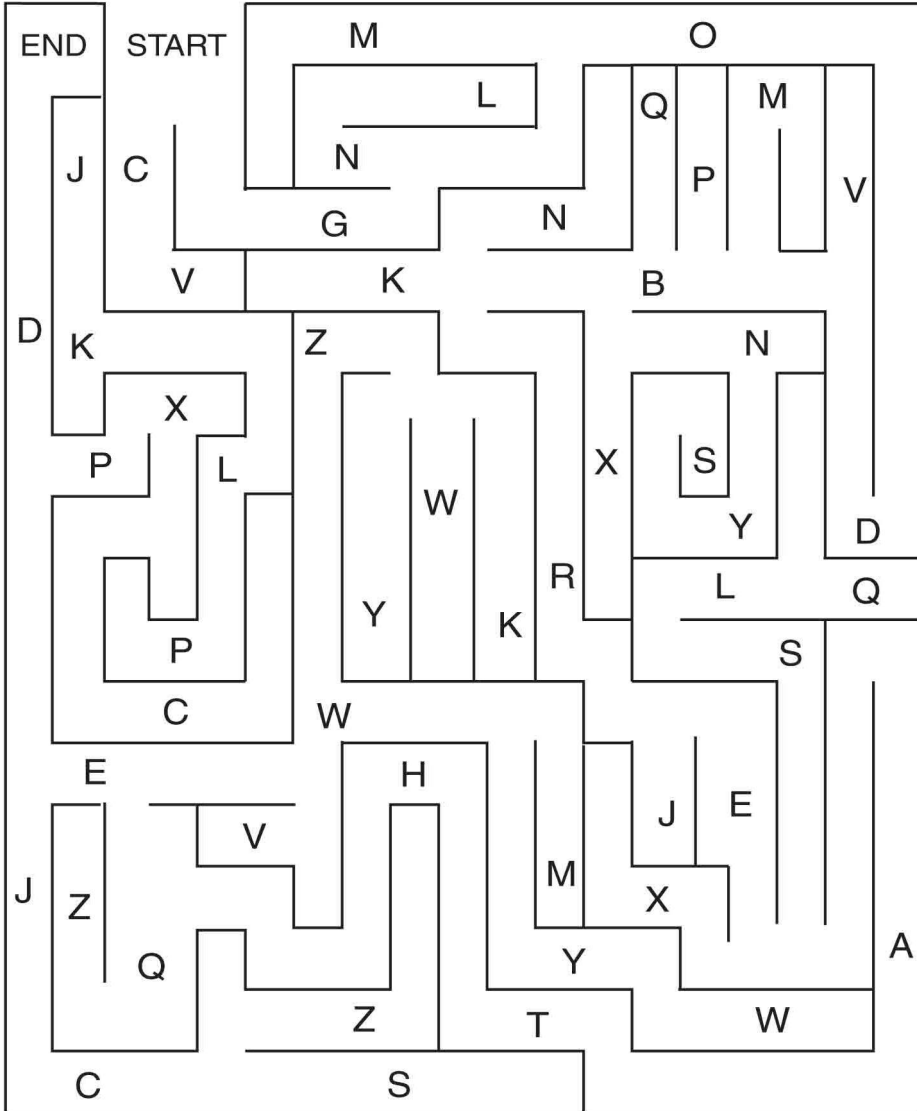

“All Scripture is _____
_____.”

What else does this letter say
the Bible is useful for?

In each row, cross out (in order) the letters of the word “TIMOTHY”.
The remaining letters will spell out a word.
Transfer them to the lines below.

3. C O R T I R E M C O T T I H N Y G

5. T R I I M G H O T T E O U S H N E Y S S

1. T T I E M A O C T H H I Y N G

4. T T R A I I M N O I T N H G Y

2. R E T B I U K M I O N T G H Y

“ _____ , _____ ,
1 2
_____ and _____
3 4
in _____ .”
5